

HDMI EXTENDER

User Manual

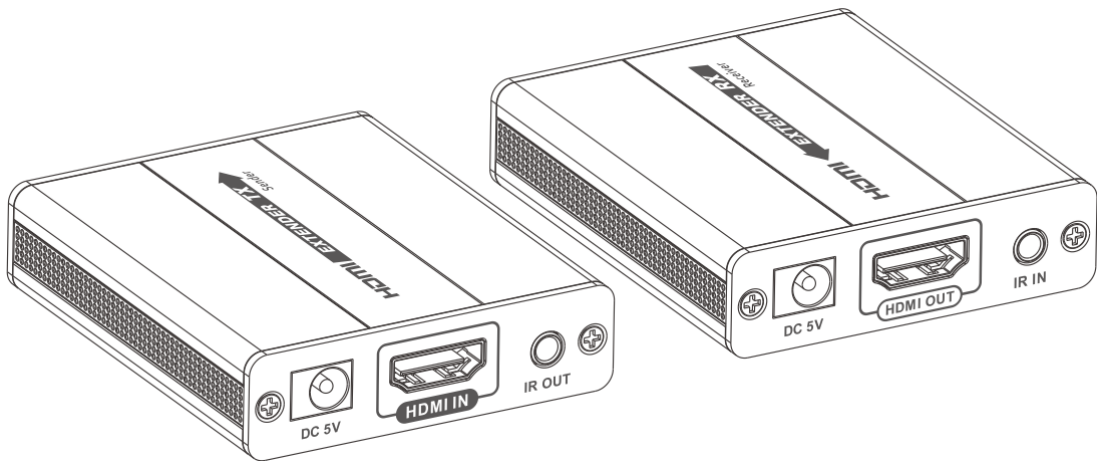

Thank you for purchasing this product. For optimum performance and safety, please read the instructions carefully and keep the manual for future reference.

Important Safety Notice

Please read below safety instructions carefully before installation and operation:

1. Do not hot plug when it is working.
2. Do not mix up the transmitter unit (TX) and the receiver unit (RX) , IR blaster extension cable and IR receiver extension cable before installation.
3. Use DC5V/1A power supply only. Make sure specification matched if using adapters not supplied by factory.

Introduction

This HDMI Extender is a solution for transmission and extension uncompressed full HD 1080p@60Hz HDMI signal over a signal

CAT5/5e/6 network cable. It includes a transmitter unit (TX) and a receiver unit(RX), working as a pair. Long transmission distance is up to 120 meters with zero latency. This HDMI Extender support IR passback for remote control source device from receiver site easily. This product is perfect for AV transmission in applications of HD conference system, HD video shooting, HD multimedia education system, HD digital advertising and signage etc.

Feature

1. Plug and play, without installation.
2. Include a transmitter unit (TX) and a receiver unit (RX), working as a pair.
3. Transmission distance up to 120m via CAT6 cable, 100m via CAT5E cable, 80m via CAT5 cable.
4. Support IR passback for remote control source device to receiver site easily.
5. Uncompressed and zero latency.
6. Support resolution is up to full HD 1080p@60Hz.
7. Compliant with CAT5/5e/6 for long distance transmission.

Package Contents



Transmitter unit
(TX) × 1pcs



Receiver unit
(RX) × 1pcs



User manual × 1pcs

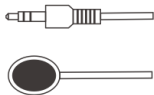

IR blaster
extension cable × 1pcs

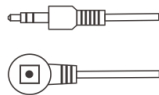

IR receiver
extension cable × 1pcs

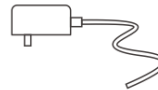

Power supply × 2pcs

1. HDMI source device(computer graphics card, DVD,PS3, HD monitoring equipment etc).
2. HDMI display device like SDTV, HDTV, projector with HDMI port.
3. UTP/STP CAT5/5e/6 cable, follow standard IEEE-568B.

Penal Description

1. Transmitter unit(TX)

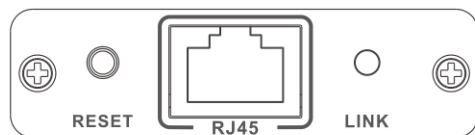

① ② ③

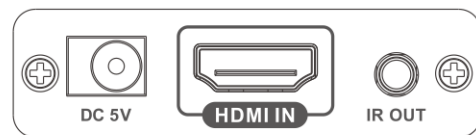

④ ⑤ ⑥

①	Reset button	Restart the unit
②	RJ45 signal output	Connect with network cable
③	LINK indicator	LED turns on all the time with HDMI signal transmission, flashes with no signal transmission
④	Power input	Connect with DC5V1A power adapter
⑤	HDMI signal input	Connect with source device
⑥	IR signal output	Connect with IR blaster extension cable

2. Receiver unit (RX)

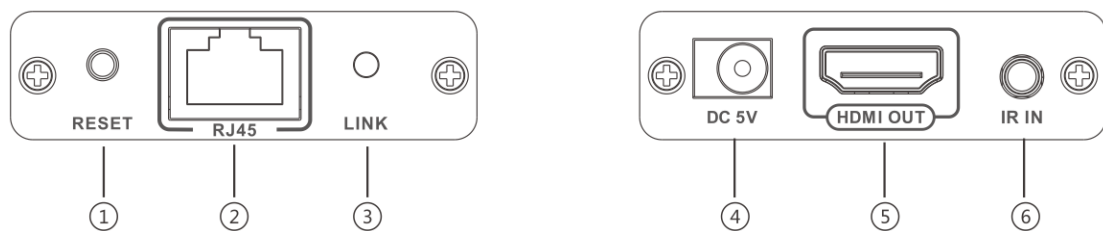

①	Reset button	Restart the unit
②	RJ45 signal input	Connect with network cable
③	LINK indicator	LED turns on all the time with HDMI signal transmission, flashes with no signal transmission
④	Power input	Connect with DC5V1A power adapter
⑤	HDMI signal output	Connect with display device
⑥	IR signal input	Connect with IR receiver extension cable

Installation and Connection



1. How to make a CAT5/5E/6 network cable Follow the standard of IEEE-568B:

1. white and orange; 2. orange; 3. white and green;
4. blue; 5. white and blue; 6. green;
7. white and brown; 8. brown.

2. Connection

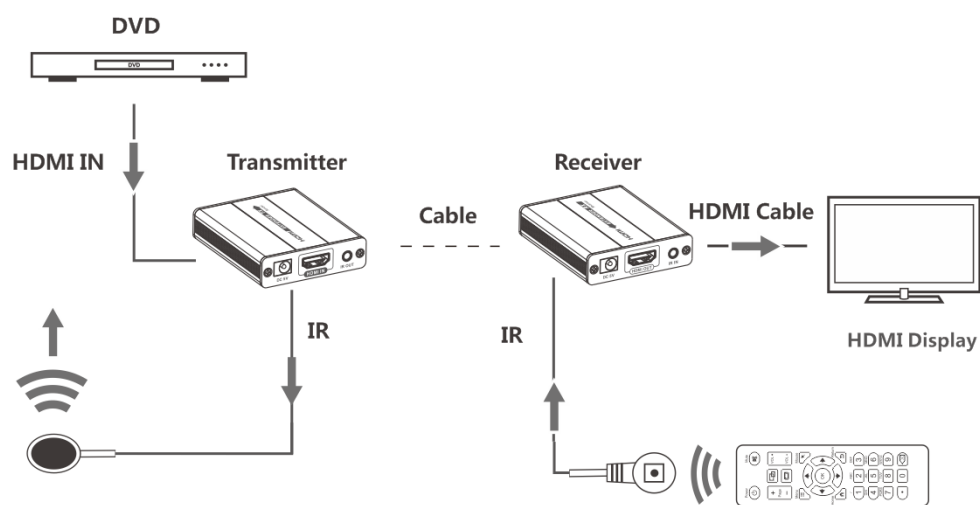

3. Connection instruction

- 1) Connect source device to Transmitter unit (TX), and display device to Receiver unit (RX) via HDMI cables
- 2) Connect Transmitter unit (TX) and Receiver unit (RX) via network cables (CAT5, CAT5e or CAT6)
- 3) Plug the power supply to Transmitter unit only, each unit will power up then initialize itself, this HDMI extender works

4. IR User Guide

- 1) IR blaster extension cable should plug in the IR OUT port of TX (Transmitter) unit of HDMI extender, and the IR receiver extension cable should plug in the IR IN port of the RX(Receiver) unit.
- 2) The emitter of IR blaster should as close as possible to the IR receiver window of the signal source device.
- 3) Using the IR remote controller of the signal source device towards the IR receiver (connected to the RX), to remote control source media playback.

FAQ

Q: No image output?

- A: 1) Check and make sure all cables are connected well;
2) Restart the TX/RX by “RESET” button.

Q: RX” LINK” indicator is flashing all the time?

- A: 1) Make sure network cable connection follows the standard of IEEE568B;
2) Check whether transmitter has HDMI signal input;
3) Reset transmitter and receiver and reconnect.

Q: Receiver "LINK" led lights on all the time but no image output?

- A: 1) Make sure the monitor supports the current HDMI signal mode;
2) Make sure HDMI cable is well connected with TV;
3) Make sure the network cable is fine copper wires.

Specification

Items		Specification
Power Supply	Voltage/Current	DC5V/1A
	Power consumption	TX: 2W RX: < 2W
HDMI Performance And Interface	HDMI compliance	HDMI1.3
	HDCP compliance	HDCP1.4
	HDMI resolution	720x576@50Hz, 720x480@60Hz, 1280x720@60Hz, 1920x1080@60Hz, 640x480@60Hz, 800x600@60Hz, 1024x768@60Hz, 1280x800@60Hz, 1280x1024@60Hz, 1440x900@60Hz, 1680x1050@60Hz
	Supports audio formats	PCM
	Maximum transfer rate	10.2Gbps
	Input and output TMDS signal	0.5 ~ 1.5Vp-p(TMDS)
	Input and output DDC signal	5Vp-p(TTL)
	Input cable length	≤8m(AWG24)
	Output cable length	≤8m(AWG24)
Transmission length	CAT5	80m
	CAT5E	100m
	CAT6	120m
Protection Level	Electrostatic protection of the whole machine	1a contact discharge level 3, 1b air discharge level 3, implementation of the standard: IEC61000-4-2
Operating Environment	Working temperature	0 ~ 60°C
	Storage temperature	-10 ~ 70°C
	Humidity (no condensation)	0 ~ 90%
Body Properties	Dimension	69.57(L) x 58.80(W) x 16.10(H)mm
	Material	Aluminium alloy material + crystal panel
	Treatment process	Grit blast
	Color	Black
	Weight	TX:70g, RX:70g

Disclaimer

* The product name and brand name may be registered trademark of related manufacturers.TM and ® may be omitted on the user manual.

The pictures on the user manual are just for reference,and there may be some slight difference with the real products.

We reserve the rights to make changes without further notice to a product

or system described herein to improve reliability, function or design.

Disclaimer