

B53

3MP with D/N, Adaptive IR, Superior WDR, Fixed Lens



- 3 Megapixel
- Day & Night with Adaptive IR LED
- Fixed Lens with f1.9mm/F2.8
- Superior WDR
- Wide Angle
- Super wide angle
- Event trigger, response and notification

► Specifications

Device

Product Type	Dome
Maximum Resolution	3MP
Application Environment	Indoor
Image Sensor	Progressive Scan CMOS
Sensor Size	1/3 "
Effective Pixels	2048(H) X 1536(V) (3.15 MP)
Day / Night	Yes
Low Light Sensitivity	Standard
Minimum Illumination	Color: 0.1 lux at F2.8 (30 IRE, 2400 K); B/W: 0 lux at F2.8 (IR LED on)
Color to B/W Switch	ISP based switch, configurable
Mechanical IR Cut Filter	Yes
IR Sensitivity Range	700-1100nm
IR LED	Adaptive IR LED x 10 (850 nm)
IR Working Distance	40m
Electronic Shutter	1/5-1/2000 second (manual mode); 1/5-1/10000 second (auto mode)
Horizontal Resolution (TV Lines)	1450 TVL

S/N Ratio	52 dB
-----------	-------

Lens

Focal Length	Fixed focal, f1.9mm
Aperture	F2.8
Iris	Fixed iris
Focus	Fixed focus
Lens Mount	Board mount
Horizontal Viewing Angle	129.56° (overview area) 79.0° (high detail area)
Vertical Viewing Angle	96.4°
Viewing Angle Adjustment	Pan: 0°-350°, Tilt: 17°-163°, Rotation: 0°-350°

Video

Compression	H.264 (Baseline/ Main/ High profile), MJPEG
Maximum Frame Rate vs. Resolution	20 fps at 2048 x 1536 30 fps at 1920 x 1080 30 fps at 1280 x 720 30 fps at 800 x 600 30 fps at 640 x 480 15 fps at 320 x 240
Multi-Streaming	Simultaneous dual streams based on two configurations
Bit Rate	28Kbps - 6Mbps (per stream)
Bit Rate Mode	Constant, Variable
Wide Dynamic Range	Superior WDR (110 dB)
Image Enhancement	White Balance, Brightness, Contrast, Sharpness, Automatic gain control, Flickerless
Digital Noise Reduction	DNR
Privacy Mask	4 configurable regions
Text Overlay	Yes
On-Screen Graphics	Yes
Server-based Analytics	Object Line Counting, People Counting, Face Detection, Object Based Motion Detection, Tamper, Object Line Crossing Detection, Object Enter Area Detection, Missing Object Detection, Unattended Object Detection, Smoke Detection, Heat Map, Dwell Time, People Queue Detection, (Require PC-based or standalone IVS or ALPR Server. Contact ACTi support for recommendations on how to maximize analytical accuracy)
Image Orientation	Flip, Mirror

Audio

Audio Type	2-way, Line-in, Line-out
Audio Compression	8 kHz, 16 bit encoding, Mono, PCM, G.711

Network

Network Protocol & Service	IPv4/v6, TCP, UDP, DHCP, PPPoE, HTTP, HTTPS, DNS, DDNS, NTP, RTP, RTSP, RTCP, SMTP, FTP, IGMP, ICMP, ARP, Bonjour, UPnP, QoS, SNMP, IEEE 802.1X
Ethernet Port	1 x RJ-45 connector
Security	IP address filtering, HTTPS encryption, Password protected user level, Anonymous login, IEEE 802.1X network access control

Event

Event Trigger	Video motion detection (3 regions), External device through digital input, Sound detection, Tampering detection
---------------	---

Event Response | Notify control center, Change camera settings, Command other devices, E-mail notification with snapshots, Push notification to mobile device, Save video to local storage, Upload video or snapshot to FTP server, Upload video to NVR server, Activate external device through digital output

Integration

Unified Solution	Fully compatible with ACTi software
Software Development Kit	Yes
GPS Position	Manual setting
ONVIF Compliant	Yes, Profile S, Profile G, Profile Q
GB28181 Compliant	Yes
Web Browser	IE 11
Auto Firmware Upgrade	Yes

Interface

Audio Interface	Terminal block
Local Storage	MicroSDHC, MicroSDXC memory card slot (card not included)
Digital Input/Output	1/1

General

Power Source	DC 12V, PoE Class 2 (IEEE802.3af)
Power Consumption	6.49 W (PoE)
Weight	508g (1.120lb)
Dimensions	(Ø x H): 146mm x 113.9mm (5.7" x 4.5")
Environmental Casing	Vandal resistant (IK09)
Mount Type	Surface, Gang Box, Flush, Pendant, Converter for NPT Standard Mounts, Wall Mount, Pole Mount, Corner Mount
Starting Temperature	-10°C ~ 50°C (14°F ~ 122°F)
Operating Temperature	-10°C ~ 50°C (14°F ~ 122°F)
Operating Humidity	10% - 85% RH
Approvals	CE, FCC, IK09, UL (for optional PoE injector and power adapter)
Warranty	3 Year(s). For extended warranty offering, see http://www.acti.com/support/warranty

► Photo Indication

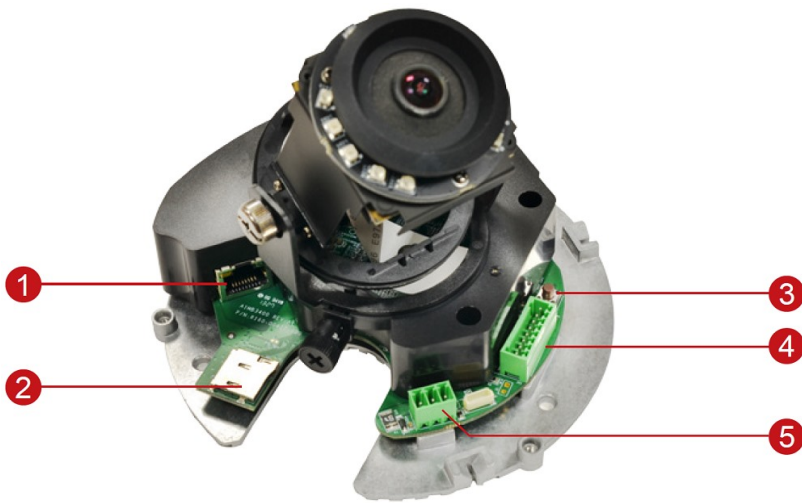

- 1 Ethernet Port
- 2 Memory Card Slot
- 3 Reset Button
- 4 Digital Input/Output
- 5 DC 12V Power Input



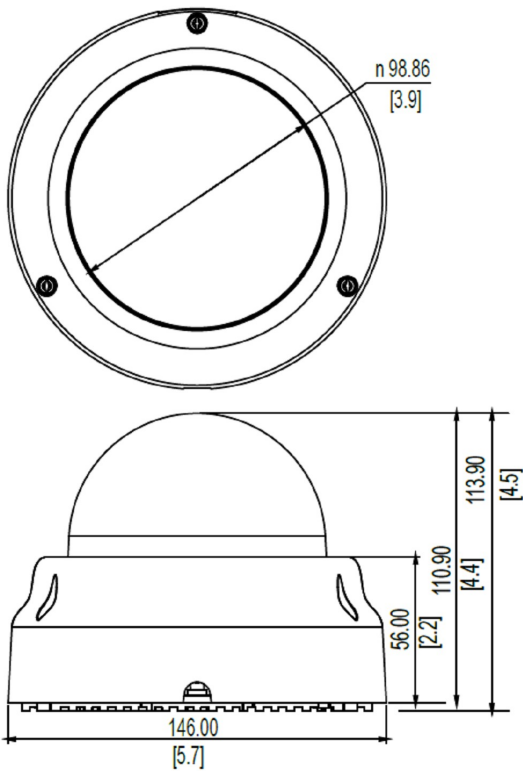













► Dimension Diagram



Unit: mm [inch]

▶ Related Products

Mounting Accessories - Camera Mount

PMAX-0101		Mount Kit for all Dome Cameras (except Mini Domes)
PMAX-0102		Straight Tube
PMAX-0103		Straight Tube with Bracket
PMAX-0104		Extension Tube
PMAX-0302		Gooseneck with Bracket
PMAX-0303		Gooseneck
PMAX-0305		Heavy Duty Wall Mount
PMAX-0313		Heavy Duty Wall Mount for Indoor Domes (for B5x, B6x, D6x, E6x, I5x)
PMAX-0402		Corner Mount
PMAX-0503		Pole Mount (for PMAx-0102, PMAx-0312, PMAx-0313, PMAx-0314, PMAx-0702, PMAx-1106, PMAx-1107), supports 5.25" to 8.5" Poles
PMAX-0505		Pole Mount (for B4x, B41x, E44, E45, E46, E48, E44A, E45A, E46A, E41x, I4x, PMAx-0312, PMAx-0313, PMAx-0314, PMAx-0330), supports 2" to 3" Poles
PMAX-0702		Junction Box for PTZ and Dome Cameras
PMAX-0803		Gang Box Converter for Indoor Domes, supports 4" Square and Two-Gang Boxes
PMAX-0807		Gangbox Converter (for PMAx-0102, PMAx-0312, PMAx-0313, PMAx-0314, PMAx-0321), supports Two-Gang Boxes
PMAX-0808		Converter Ring, 1.5" NPT for Third-Party Mounting Accessories
PMAX-1003		Flush Mount Kit (for D6x, D7x, D8x, E61~E67, E7x [except E78], E81~E88)

Note: Some mounting accessories may need additional accessories for installation. Please check www.acti.com/mountingselector for more information.

Lenses - Fixed Lens

PLEN-4101		Fixed Focal f1.9mm, Fixed Iris F2.8, Fixed Focus, Board Mount Lens
-----------	---	--

Dome Covers - Transparent Dome Cover

R701-70006



Transparent Dome Cover Only (for B51, B52, B53, B61~B67, B81~B87, B94~B97, D61~D65, D6xA, D7x, D7xA, D8x, D8xA, E61~E69, E6xA, E71~E77, E7xA, E81~E88, E8xA, Q61, Q81)

Dome Covers - Smoked Dome Cover

PDCX-1101



Vandal Proof Smoked Dome Cover for B51, B52, B53, D6x(A), E6x(A), E7x(A), E8x(A), KCM-3311, KCM-7111, KCM-7311 (except E610, E78, E89)

Power Supply Accessories - Power Adapter

PPBX-0011



Power Adapter AC 100~240V, with universal connectors for all DC12V powered devices

Power Supply Accessories - PoE Injector

PPOE-0001



PoE Injector IEEE 802.3af compliant, AC 100~240V, with universal connectors

Network & Storage Peripherals - Data Switch

PPSW-0100



PLANET FGSD-910HP 8-Port 802.3at PoE Switch (PoE Budget 120W)

PPSW-0101



PLANET GS-4210-8P2T2S 8-Port Gigabit 802.3at Managed PoE Switch (PoE Budget 240W)

PPSW-0102



PLANET FGSD-1011HP 8-Port 802.3at PoE Switch (PoE Budget 120W)

PPSW-1101



PLANET GS-4210-24PL4C 24-Port Gigabit 802.3at Managed PoE Switch (PoE Budget 440W)

PPSW-2101



4-Port 802.3at PoE Switch (PoE Budget 62W)

PPSW-3100



PLANET FGSW-1816HPS 16-Port 802.3at PoE Switch (PoE Budget 220W)

Extenders - PoE Extender

PPEX-0100



Veracity OUTREACH Max Power over Ethernet (PoE) Extender

Extenders - PoE over Coaxial Extender Kit

PPOC-0100



Planet LRP-101C-KIT Power over Coax Adapter Kit

Audio Devices - Microphone

PMIC-0100



Active Microphone Omnidirectional for all Cameras with Line-in Audio

Illuminators - IR LED Illuminator

PLED-0200



SPINLUX (SL-A2IRXX10-24CL) IR Illuminator 10° Angle with 120 m approx. range

PLED-0201





SPINLUX (SL-A2IRXX25-24CL) IR Illuminator 25° Angle with 50 m approx. range

PLED-0202		SPINLUX (SL-A2IRXX35-24CL) IR Illuminator 35° Angle with 25 m approx. range
PLED-0204		SPINLUX (SL-A2IRXX25-48CL) IR Illuminator 25° Angle with 80 m approx. range
PLED-0205		SPINLUX (SL-A2IRXX35-48CL) IR Illuminator 35° Angle with 40 m approx. range

Product Demo - Camera Demo Kit

PCDK-0001		Camera Demo Kit Rack Box (350 x 550 x 140 mm) for all cameras except Mini Domes
-----------	---	---

Installation Support - Camera Installation Kit

PMON-1001-010		Camera Installation Kit for use with iOS Device with belt bag, battery and charger (US, AC 110~240V)
PMON-1001-011		Camera Installation Kit for use with iOS Device with belt bag, battery and charger (Europe, AC 110~240V)
PMON-2000		Camera Installation Kit